

This document and its contents are the exclusive property of PPUH "Supron 3" Spółka z o.o., and may not be copied, reproduced, transmitted or communicated to a third part, or used for any purpose without written permission.

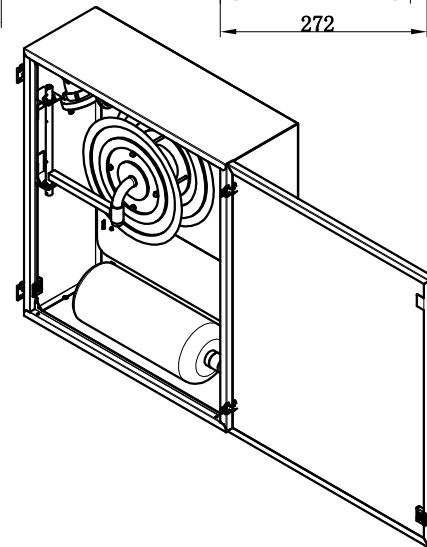
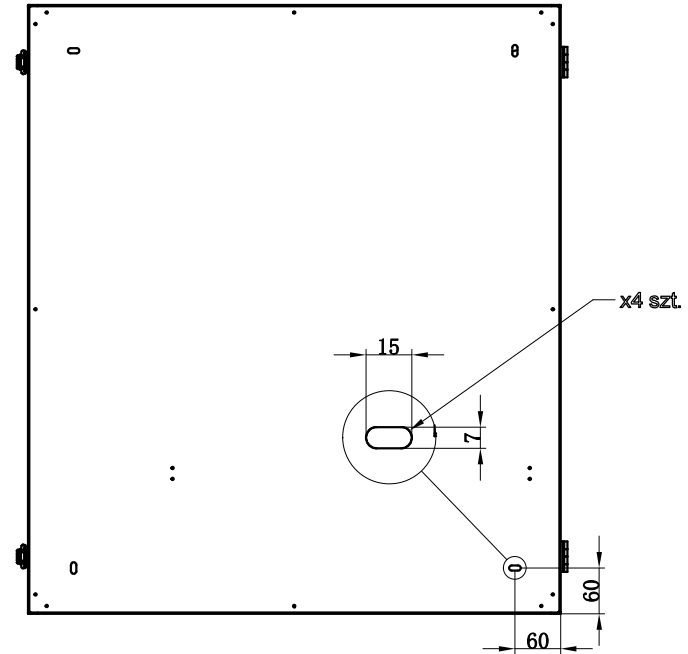
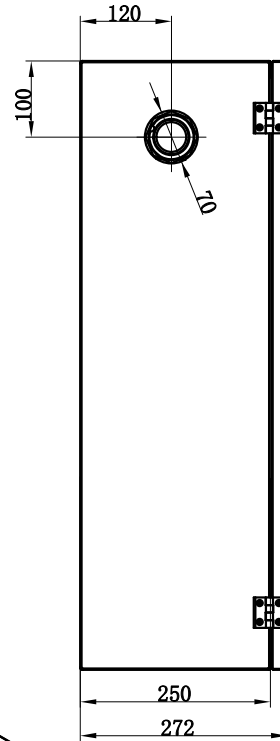
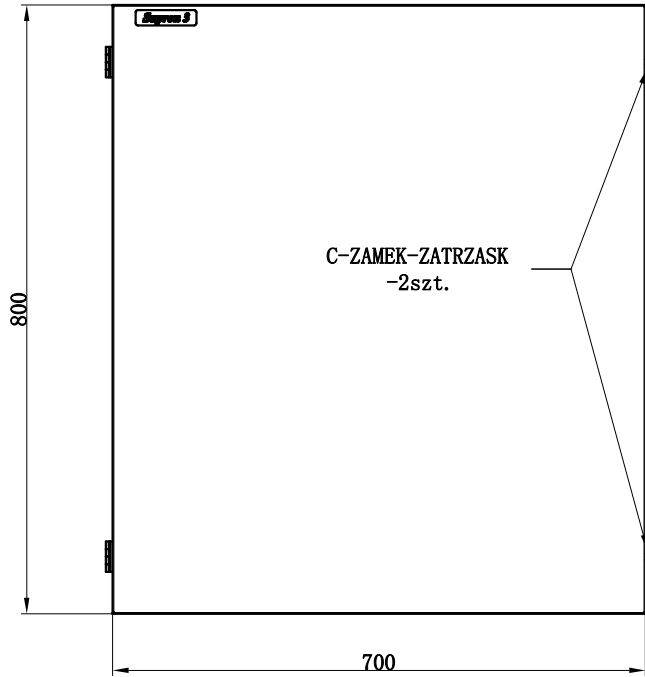
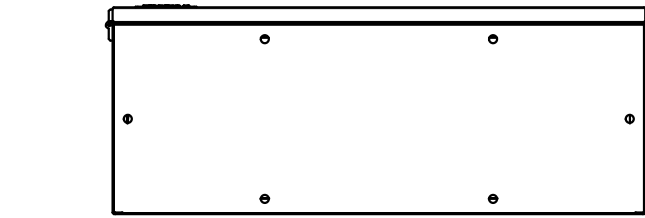
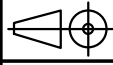
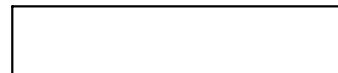

UWAGA: HYDRANTY WEWNĘTRZNE 52 SĄ MONTOWANE W SIECI INSTALACYJNEJ 2" Z ZAWOREM HYDRANTOWYM 52

Nazwa i/lub logo przedsiębiorstwa:		Nazwa rysunku: S-520-C3G6GW20-OFT-XXXX S-520-C3G6GW15-OFT-XXXX		 Arkusz: 1/1
		Numer rysunku: PN-EN 671-1 (Z-52/20) OM PN-EN 671-1 (Z-52/15) OM		