

This document and its contents are the exclusive property of PPUH "Supron 3" Spółka z o.o., and may not be copied, reproduced, transmitted or communicated to a third part, or used for any purpose without written permission.

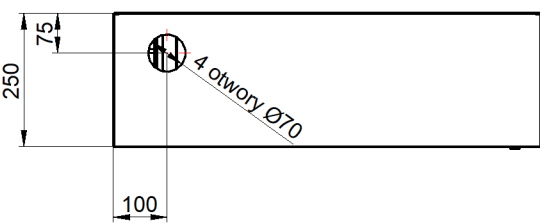

**Wszystkie otwory przyłączeniowe do wybicia Ø70.  
W pokrywie górnej, boku i plecach szafy.**

S-C-RAMIE600

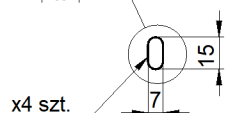
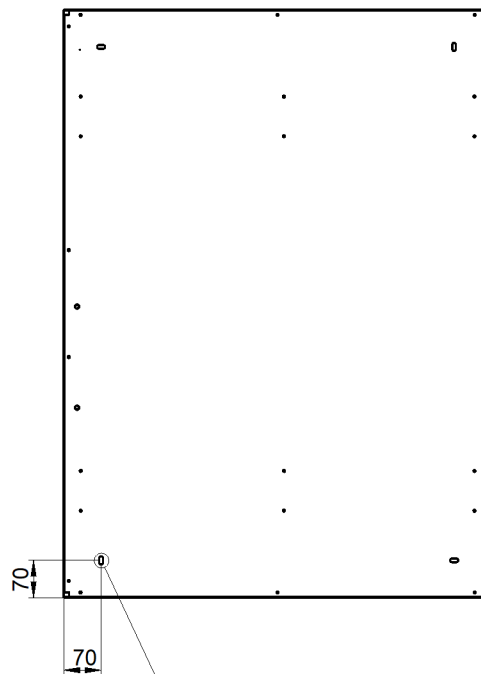
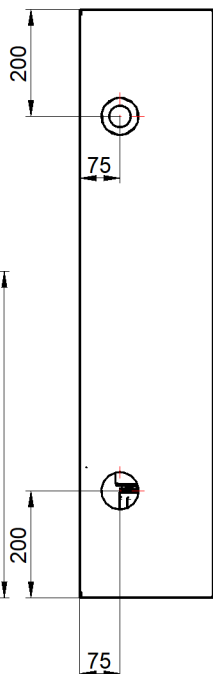
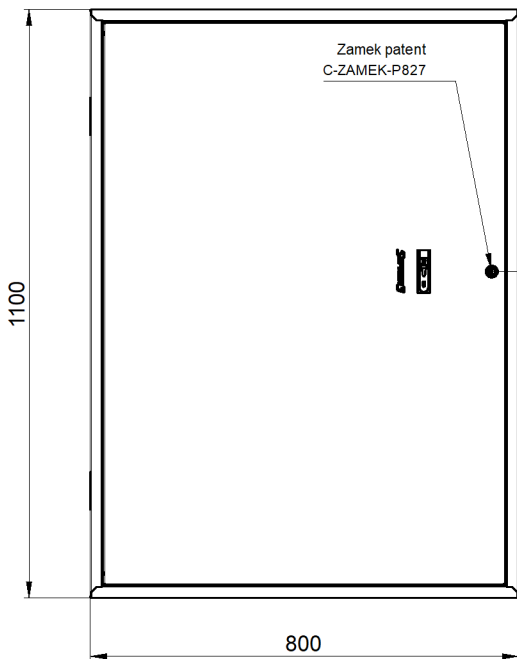
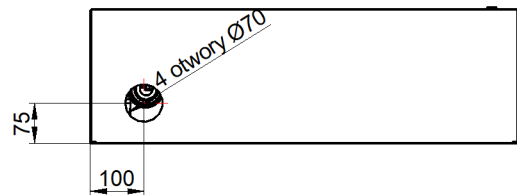
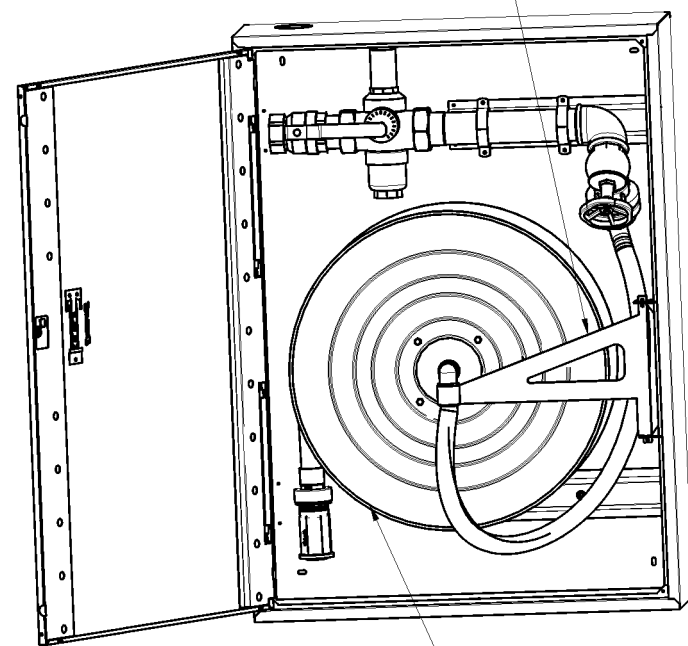

Tarcza Ø 600

Nazwa i/lub logo przedsiębiorstwa:		Nazwa rysunku: S-HQ33-Z20-OPF-XXXX S-HQ33-Z30-OPF-XXXX		
		Numer rysunku: PN-EN 671-1 (Z-33/20) HQ PN-EN 671-1 (Z-33/30) HQ		