

This document and its contents are the exclusive property of PPUH "Supron 3" Spółka z o.o., and may not be copied, reproduced, transmitted or communicated to a third part, or used for any purpose without written permission.

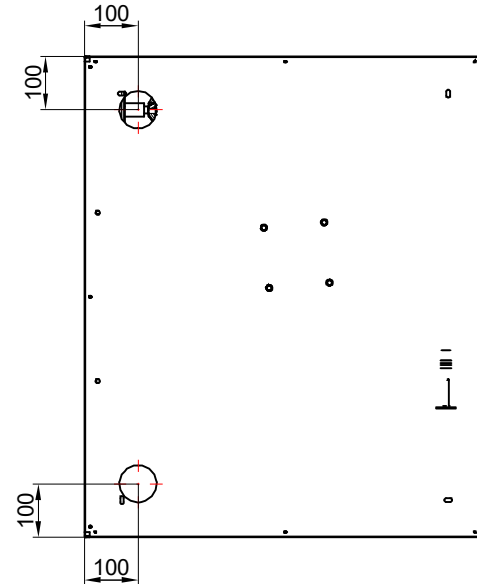

Tarcza Ø600

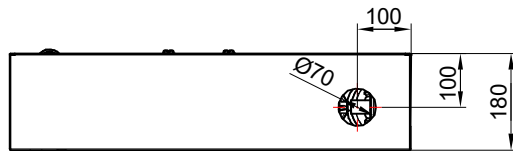
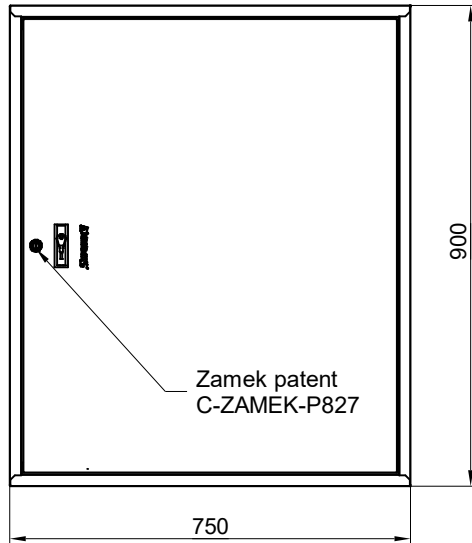
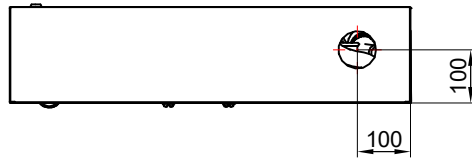
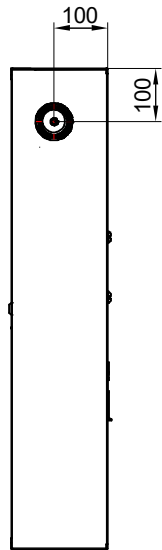
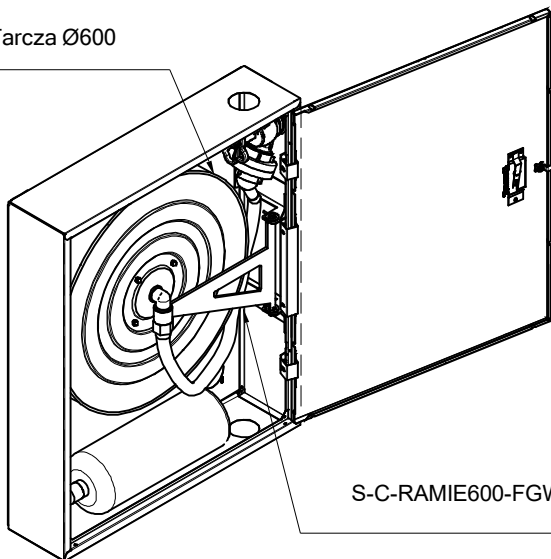

S-C-RAMIE600-FGW

Wszystkie otwory przyłączeniowe do wibici Ø70 lub Ø35, w pokrywie górnej, boku i plecach szafy

UWAGA:
 HYDRANTY WEWNĘTRZNE TYP PN/EN 671-1(HYDRANTY 25) SĄ MONTOWANE W SIECI INSTALACYJNEJ 1" Z ZAWOREM HYDRANTOWYM 25
 W HYDRANTACH TYP PN/EN 671-1(HYDRANTY 25)ISTNIEJE MOŻLIWOŚĆ PODŁĄCZENIA ZAWORU 52 PRZY SIECI INSTALACYJNEJ 2"

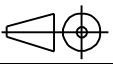
Nazwa i/lub logo przedsiębiorstwa:		Nazwa rysunku:	
		Hydrant wewn ętrzny	
		Numer rysunku:	
			
		Arkusz:	
		1/1	