

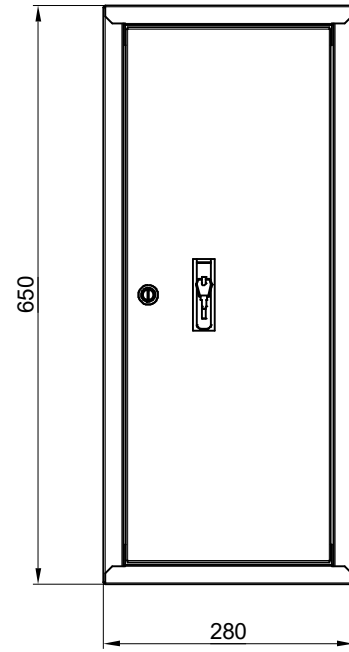

This document and its contents are the exclusive property of PPUH "Supron 3" Spółka z o.o., and may not be copied, reproduced, transmitted or communicated to a third part, or used for any purpose without written permission.

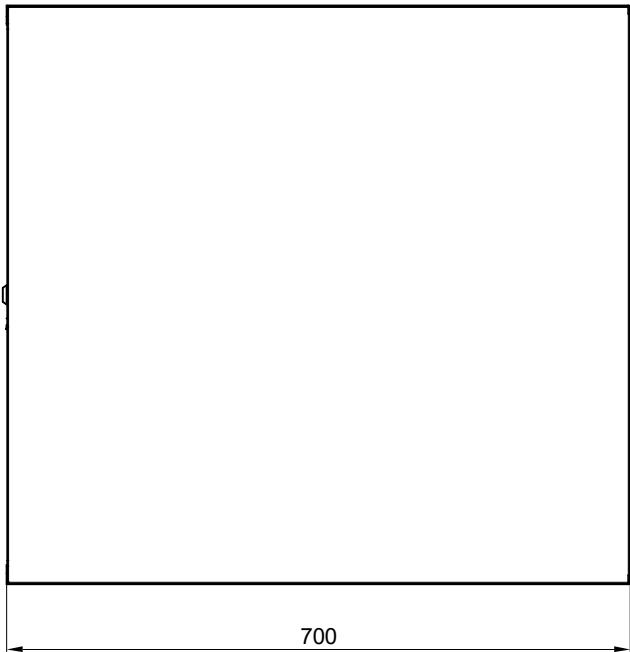

Tarcza Ø 500

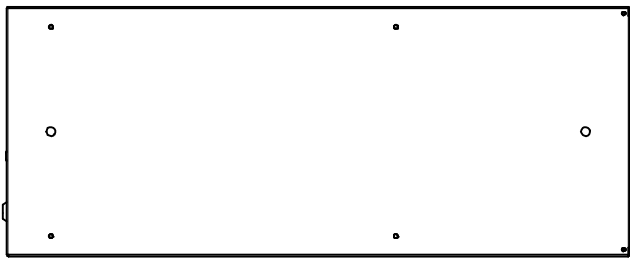
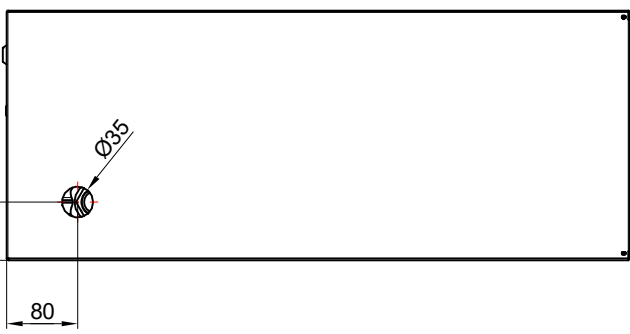
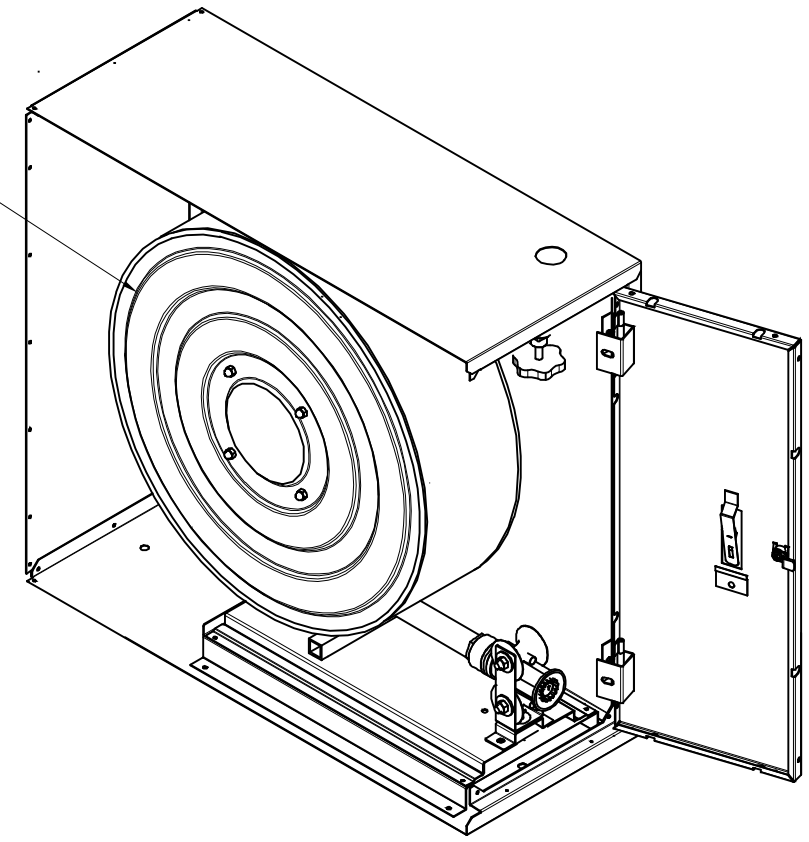

UWAGA:  
 HYDRANTY WEWNĘTRZNE TYP PN/EN 671-1(HYDRANTY 25) SĄ  
 MONTOWANE W SIECI INSTALACYJNEJ 1" Z ZAWOREM HYDRANTOWYM 25

Nazwa i/lub logo przedsiębiorstwa: 	Nazwa rysunku: Hydrant wewnętrzny Numer rysunku: PN-EN 671-1 (Z-25/20) wykonanie boczne PN-EN 671-1 (Z-25/30) wykonanie boczne

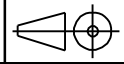

Arkuszy:  
1/1